

6 5 4 3 2 1

H

G

F

E

D

C

B

A

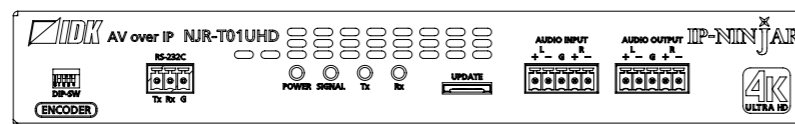
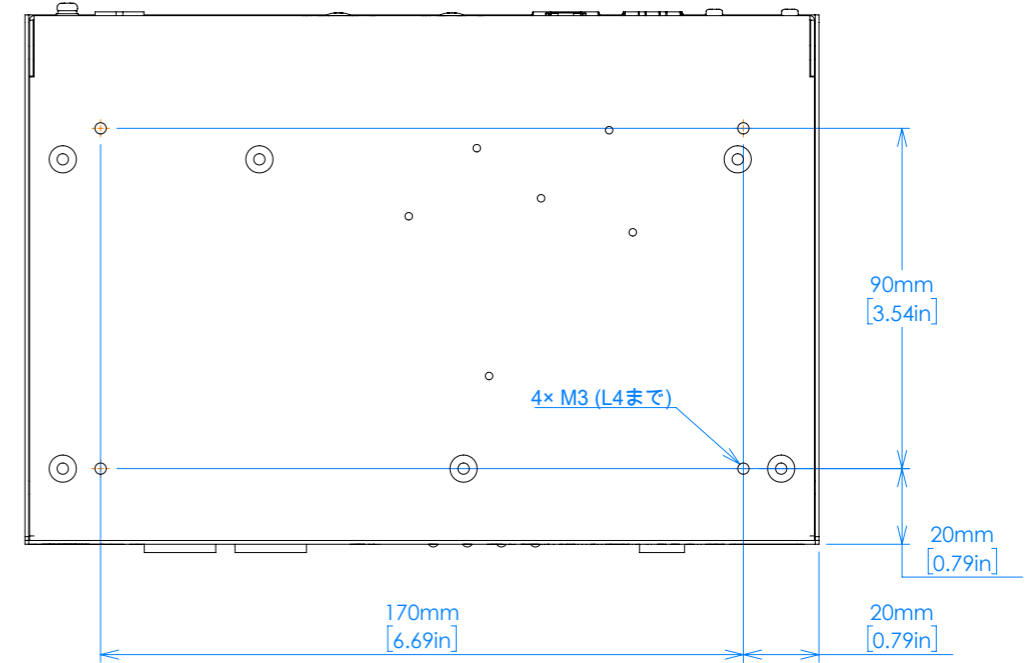
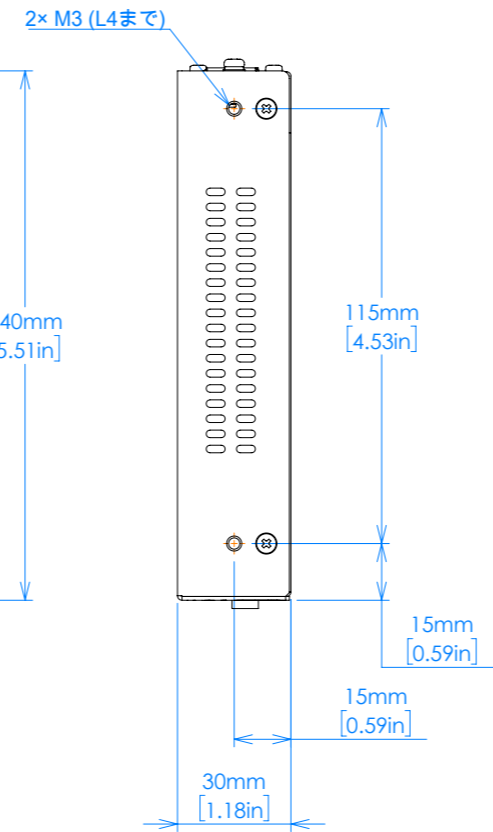
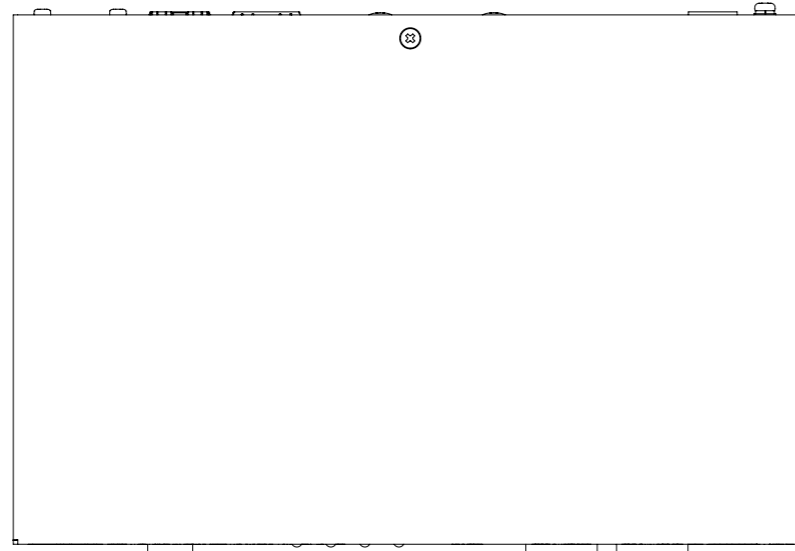
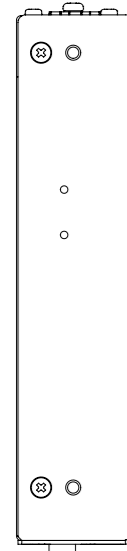
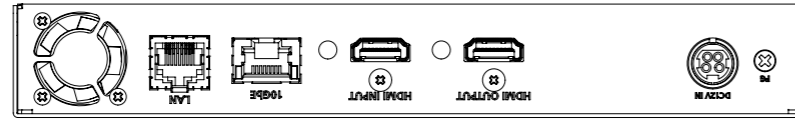

UNITS mm [in]		MODEL NJR-T01UHD-CAT	
DRAWN Shibata 2019/09/13	CHECKED Watanabe 2019/09/13	APPROVED Kadowaki 2019/09/13	PART NAME 外観図 DWG No. 110E01
IDK Corporation www.idk.co.jp			REVISION D1
SCALE : 1:2 (A3)			PAGE 1 / 2

6 5 4 3 2 1 2016/08/18 図種Ver 1.00

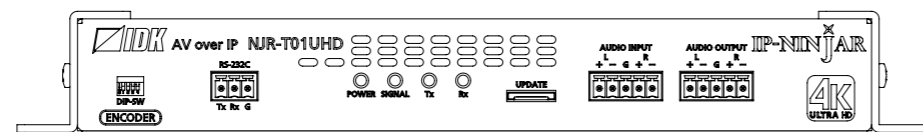
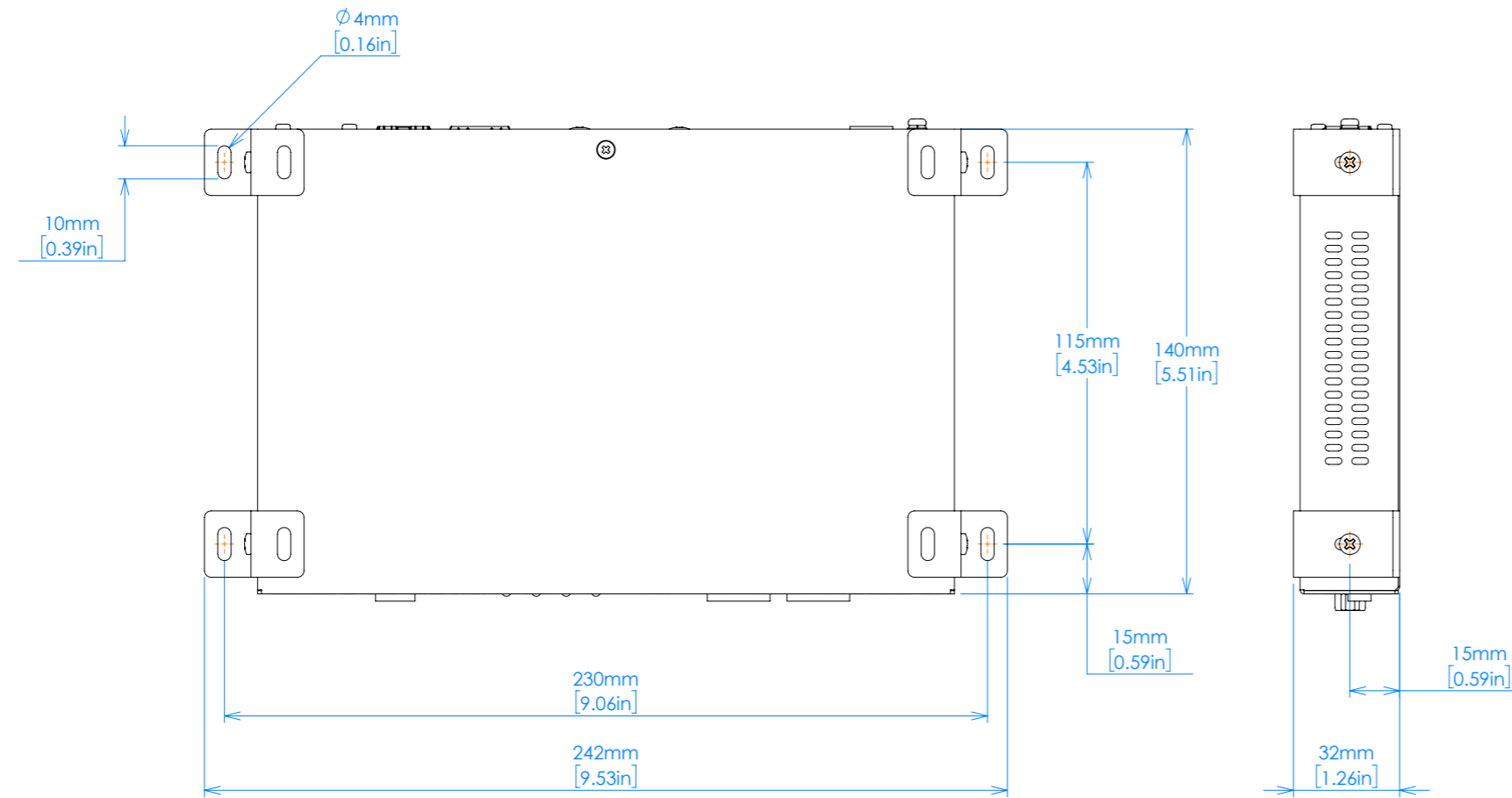

固定用プレート FP-Z30 を取り付けた図となります。

MODEL	NJR-T01UHD-CAT	
PART NAME	外観図	
DWG No.	110E01	REVISION D1
IDK Corporation	SCALE : 1:2 (A3)	PAGE 2 / 2